



Watching Video

Concrete Pump / Boom Pump

ECP36ZX

Boom Type

4 section Z folding

Vertical Reach

36m

Horizontal Reach

31.5m

Depth Reach

23.4m

Delivery Pipe Diameter

125mm

Slewing Range

370°

Outrigger

Diagonal extension (Front)

Swing-type (Rear)



FFH SYSTEM (Free Flow Hydraulic)

This type of FFH Hydraulic Pressurized Systems combined with **Rexroth**[®] pumps and **Hawe**[®] boom control block is widely recognized to all over the world due to efficiency and stability. Currently Everdigm Pumps are applying these systems for longtime and widely known and also proven the products to everyone. Based on these facts FFH systems are used all over the world and mostly welcomed. Efficient pumps, less boom bouncing and less noise for while it operates. As above all, these reasons they are providing comfortable working area.

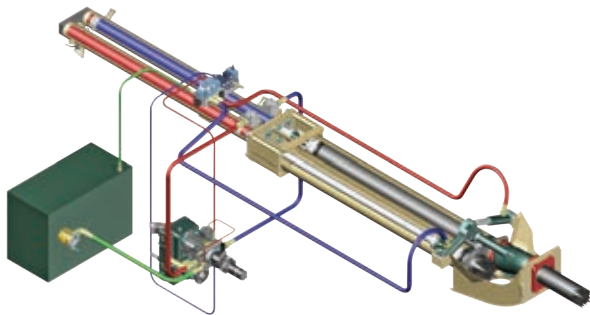

FEATURES

PUMPING UNIT

Closed-loop Free Flow Hydraulic System
 Inductive Proximity Switch and Indicator
 Single Lip Concrete Piston
 Hard-Chromed Concrete Cylinder

BOOM & STRUCTURE

4 Stage Z-Folding Boom
 Diagonal Extension Front Outrigger (One Stage)
 Swing Rear Outrigger (One Stage)
 Outrigger Pilot Check Valves
 Rack Gear Cylinder Type Boom Slewing
 High Pressure End Hose (3m)
 Boom & Deck Pipe Diameter 125mm
 Greasing Port on Boom Link and Pedestal
 Bubble Gauge on Both Side
 Water Pump, Water Tank, Cleaning Hose and Spray Nozzle
 Working Light on Pedestal and Platform

HOPPER

Easy Clean Type Hopper
 Hi-Manganese Agitating Paddle
 600 Liter Volume Hopper
 Hopper Outlet Diameter 180mm
 S2018 Type S-tube (Dia.200-180mm)
 Flap Elbow (Dia.180-150mm) with Cleaning Port
 Reducing Pipe (150-125mm)
 Tungsten Carbide Wear Ring and Plate
 Hydraulic Agitator Motors on Both Side Hopper
 Working Light on Hopper

Direct connecting main pump and hydraulic cylinders
 improve pumping efficiency
 Less peak pressure & less boom bouncing by peak
 pressure control
 No need of big oil tank
 Cut down maintenance cost
 Applying suction filter
 Prevent contamination in main pump
 Centralized pumping controller
 Easy access and maintenance

CONTROL KIT

Wire Remote Control (40m Cord)
 Wireless Remote Control (Proportional)
 Remote ON/OFF Pumping
 Remote ON/FF Engine
 Infinite Variable RPM Control
 Boom Control Block
 Outrigger Control Block on Both Side
 Emergency Stop Switch
 Electric Main Control Panel and Local Controller
 Pneumatic Solenoid Valve Type PTO Control
 Stroke Changeover Switch

OPTIONAL

Boom	Twin Wall Pipe
	Auto Lubrication
	Working Light
Outrigger	Outrigger Pads and Compartment
	Cover
Hopper	Safety Device
	Vibrator
	Aluminum Platform
Platform	Water Tank Heater
	Handrail on Rear Step
	Pipe Storage Bracket on One Side Rear Outrigger
	Spare Tire Storage Bracket on Platform
Paint	Customized Color

Note) For more optional item not mentioned above please consult the manufacture.

SPECIFICATIONS

DIMENSIONS

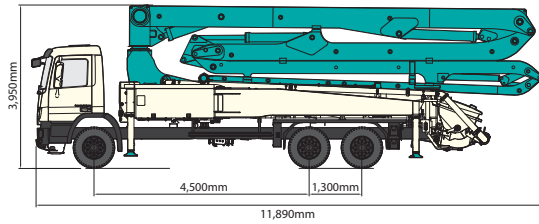

Front Axle Loading Weight	6,500kg
Rear Axles Loading Weight	19,300kg

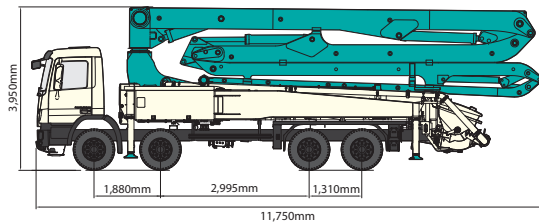

Front Axle Loading Weight	10,300kg
Rear Axles Loading Weight	16,400kg

* Weight and dimension figures here are subject to change on various chassis option and additional axle application etc.

WORKING RANGE

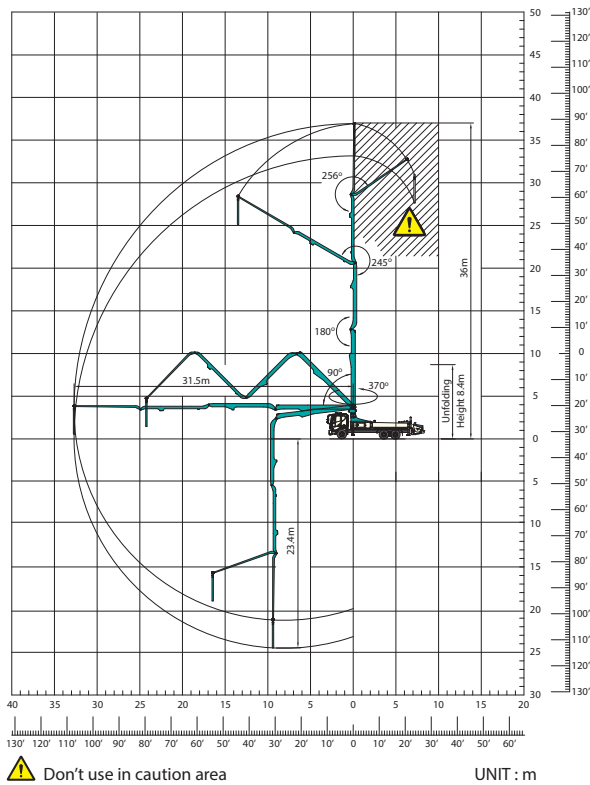

PUMP

Pump Cell	2113	2114	2116
Control System	Closed Free Flow Hydraulic		
Main Pump	A4VG125	A4VG180	A4VG125x2
Concrete Cylinder (mm)	Dia. 230	230	230
	Stroke 2,100	2,100	2,100
Drive Cylinder (mm)	Dia. 120	130	140
	Stroke 2,100	2,100	2,100
Theoretical Concrete Output (m ³ /h)	130	140	160
Theoretical Concrete Pressure (bar)	54	70	85
Stroke No.(perminute)	24	26	30
Transfer Tube Type	S-Tube, S2018 (Dia. 200-180mm)		
Volume of Hopper (liter)	600	600	600

BOOM

Folding Type	4 Stage Z-folding
Slewing Angle	370deg.
Max. Vertical Reach	36m
Max. Horizontal Reach	31.5m
Max. Depth Reach	23.4m (incl. End Hose 3m)
Unfolding Height	8.4m
End Hose Length	3m
Delivery Pipe Dia.	125mm

OUTRIGGER

Front Outrigger	One Stage Diagonal Extension Full Spread Width 6.3m
Rear Outrigger Type	One Stage Swing-out Full Spread Width 7.1m

OUTRIGGER SPREAD

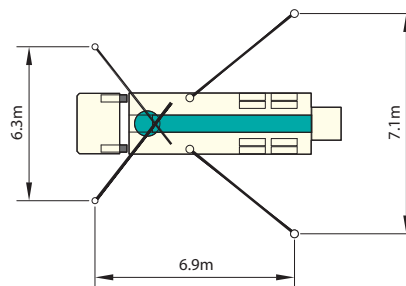

Note) Technical amendments are reserved. The specifications are subject to change with or without prior notice.

EVERDIGM

EVERDIGM is large sized company with \$250M turnover providing customers across the world with its quality products. EVERDIGM has been working and growing based on the platform of advanced quality, professionalism and real satisfaction. Standing behind the customers taking responsibility at all stage its product life cycle is EVERDIGM's commitment.

Build the Future

The spirit, "build the future", enables EVERDIGM to make a remarkable growth over 80 countries now. EVERDIGM offers the best value concrete pump which is key to build the brighter future for dealers and customers.

Concrete Pump

- Free Flow Hydraulic System
- Boom Pump Ranging from 21M to 60M
- Placing Boom of Various Design
- High Pressure Trailer and Line Pump



Truck Mounted Boom Pump Line-up (Max. Vertical Reach)

Unit : m

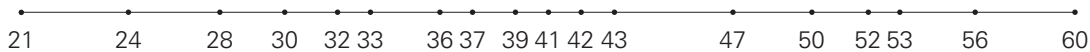

Trailer Pump Line-up (Max. Concrete Pressure)

Unit : bar



Line Pump Line-up (Max. Concrete Pressure)

Unit : bar



Placing Boom Line-up (Max. Horizontal Reach)

Unit : m

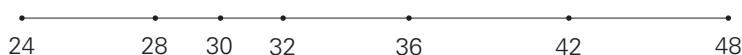

Distributed by

Head Office & Factory
332-3, Janggwan-Ri, Jincheon-Eub, Chungcheongbuk-Do, Korea
Tel_+82-43-530-3300 Fax_+82-43-530-3429

Sales & Marketing Office
Room #1203, Woolim Lion's Valley 2, 680, Gasan-Dong, Geumcheon-Gu, Seoul, Korea
Tel_+82-2-801-0800 Fax_+82-2-801-0899

@EVERDIGM Corp. Printed in Korea

