

DOOSAN

LOG LOADERS

1 – 40 METRIC TON

DX225LL	29 500 kg	65,036 lb.	155 hp (115 kw)
DX300LL-3	36 700 kg	80,910 lb.	213 hp (159 kw)



DOOSAN DELIVERS *a heritage of dedication*

DOOSAN, a strong, stable and global company, has a heritage in equipment manufacturing that began in 1937. Since 2005, we've grown to become the fifth largest construction equipment manufacturer in the world.

Doosan can be found in every area of the infrastructure support business, which encompasses many facets of the heavy construction equipment industry.

Many contractors might be surprised to know that, while Doosan is a relatively young brand in the North American construction equipment market, the organization has a global manufacturing history going back more than 75 years.

Today, Doosan Infracore Construction Equipment America (DICEA) and its affiliates are industry leaders in the engineering, manufacturing and marketing of construction equipment including skid-steers, excavators,

wheel loaders, articulated dump trucks, attachments, air compressors, lighting systems and generators as well as compact construction equipment and engine power systems.

Building your tomorrow today.

Our construction equipment group leads Doosan's infrastructure support business (ISB) segment. Other ISB businesses include:

- Forklifts & Material Handling
- Machine Tools
- Castings & Forgings
- Construction & Engineering
- Power Generation
- Water Treatment & Desalination
- Renewable Energy





Your North American partners.

Throughout our decades of selling equipment in North America, we've been building a network of dealers designed to surpass the standards for customer service. From coast to coast, there's a solid infrastructure that supports your equipment, including a parts distribution facility in Chicago and a service training facility in Georgia, sales training center in Arizona, attachments design and development in Minnesota and sales & marketing support in North Dakota.

West Fargo, ND
Sales & Marketing

Tucson, AZ
Product Training & Testing

Litchfield, MN
Heavy Attachments

Chicago, IL
Parts Distribution

Suwanee, GA
Service Training & Product Management

Atlanta, GA
DICEA, NA Headquarters

General

	UNIT	DX225LL	DX300LL-3
ENGINE			
MODEL		Doosan DL06	Doosan DLO8K
NUMBER OF CYLINDERS		6	6
RATED POWER GROSS (HP per SAE J1995)	hp (kW) @ rpm	155 (115) @ 1,900	213 (159) @ 1,800
RATED POWER NET (HP per SAE J1349)	hp (kW) @ rpm	148 (110) @ 1,900	204 (152) @ 1,800
MAXIMUM TORQUE (GROSS) (SAE J1995)	ft.-lb. (Nm) @ rpm	492 (667) @ 1,400	716 (971) @ 1,300
PISTON DISPLACEMENT	in. ³ (cc)	359 (5890)	466 (7640)
BORE AND STROKE	in. x in. (mm x mm)	3.9 x 4.9 (100 x 125)	4.3 x 5.5 (108 x 139)
STARTER	V, kW	24V x 4.5 kW	24V x 6.0 kW
BATTERIES	V, AH	2 x 12V, 100AH	2 x 12V, 150AH
AIR CLEANER		Double Element	Double Element
HYDRAULICS			
MAIN PUMPS	gpm (L/min.)	2 x 58 (2 x 220)	2 x 66 (2 x 248)
PILOT PUMP Gear Design	gpm (L/min.)	6.9 (26)	7.5 (28.5)
RELIEF PRESSURE (Normal)	psi (kg/cm ²)	4,694 (330)	4,694 (330)
RELIEF PRESSURE (Boost)	psi (kg/cm ²)	4,978 (350)	4,978 (350)
MAXIMUM SYSTEM PRESSURE			
BOOM/ARM/HEEL (Normal Mode)	psi (kg/cm ²)	4,694 (330)	4,694 (330)
BOOM/ARM/HEEL (Power Mode)	psi (kg/cm ²)	4,978 (350)	4,978 (350)
TRAVEL (Normal Mode)	psi (kg/cm ²)	4,694 (330)	4,694 (330)
TRAVEL (Power Mode)	psi (kg/cm ²)	4,978 (350)	4,978 (350)
SWING (Normal Mode)	psi (kg/cm ²)	4,694 (330)	4,694 (330)
SWING (Power Mode)	psi (kg/cm ²)	4,978 (350)	4,978 (350)
UNDERCARRIAGE			
UPPER ROLLERS		2	2
LOWER ROLLERS		9	9
NUMBER OF SHOES (LINKS PER SIDE)		48	48
TOTAL LENGTH OF TRACK	ft. in. (mm)	15'2" (4613)	16'2" (4920)
ENVIRONMENT			
SOUND LEVEL (2000/14/EC)	dB(A)	104	103
CABIN SOUND LEVEL (ISO 6396)	dB(A)	73	71
SWING MECHANISM			
SWING SPEED	rpm	11.7	9.9
SWING TORQUE	lb.-ft. (kgf-m)	60,613 (8380)	82,095 (11 350)
DRIVE SYSTEM			
TRAVEL SPEED [LOW / HIGH]	mph (km/h)	1.7 / 2.9 (2.8 / 4.6)	1.9 / 2.9 (3.1 / 4.6)
DRAWBAR PULL	lb. (kgf)	71,070 (32 237)	76,611 (34 750)
MAXIMUM GRADE	% (degrees)	70 (35°)	70 (35°)
REFILL CAPACITIES			
FUEL TANK	gal. (L)	272 (1030)	132.1 (500)
COOLING SYSTEM (RADIATOR CAPACITY)	gal. (L)	6.3 (24)	13.2 (50)
ENGINE OIL	gal. (L)	7.1 (27)	9.5 (36)
SWING DRIVE	gal. (L)	1.6 (6)	1.8 (7)
FINAL DRIVE (EACH SIDE)	gal. (L)	1.5 (5.5)	2 x 1.6 (2 x 6)
HYDRAULIC SYSTEM	gal. (L)	63.4 (240)	81.9 (310)
HYDRAULIC TANK (Level)	gal. (L)	37.2 (141)	43.6 (165)

NOTE - Where applicable, dimensions are in accordance with Society of Automotive Engineers (SAE) and ISO standards. Specifications and design are subject to change without notice. Pictures of Doosan log loaders may show other than standard equipment. All dimensions are shown in inches. Respective metric dimensions are enclosed by parentheses. Doosan Construction Equipment is manufactured with a Quality Management System that is in compliance with ISO 9001:2008.

All dimensions are given for Doosan log loaders equipped with standard tracks.

Weight

	UNIT	DX225LL	DX300LL-3
CATEGORY			
BOOM TYPE	ft. in. (mm)	20'2" (6150)	20'8" (6300)
STICK TYPE	ft. in. (mm)	12' (3660)	12'10" (3912)
HEEL	ft. in. (mm)	2'8" (813)	3'3" (990)
DIMENSIONS (DOUBLE GROUSER)			
SHOE WIDTH – 2'4" (700 mm)			
OPERATING WEIGHT (w/o GRAPPLE)	lb. (kg)	65,036 (29 500)	80,910 (36 700)
GROUND PRESSURE	psi (kgf/cm ²)	8.4 (.59)	8.2 (.58)

Hydraulic Cylinders

	UNIT	DX225LL	DX300LL-3
BOOM (2)			
BORE x ROD DIAMETER x STROKE	in. x in. x in. (mm x mm x mm)	5.5 x 3.7 x 45.0 (140 x 95 x 1143)	5.9 x 3.9 x 46.9 (150 x 100 x 1190)
ARM (1)			
BORE x ROD DIAMETER x STROKE	in. x in. x in. (mm x mm x mm)	6.5 x 4.5 x 57.2 (165 x 115 x 1454)	7.1 x 4.7 x 55.3 (180 x 120 x 1405)
HEEL (1)			
BORE x ROD DIAMETER x STROKE	in. x in. x in. (mm x mm x mm)	4.5 x 3.0 x 36.0 (115 x 75 x 915)	5.9 x 3.9 x 39.8 (150 x 100 x 1010)

The piston rods and cylinder bodies are made of high-strength steel.
A shock absorbing mechanism is fitted in all cylinders to ensure shock-free operation and extend piston life.

Specifications

Dimensions

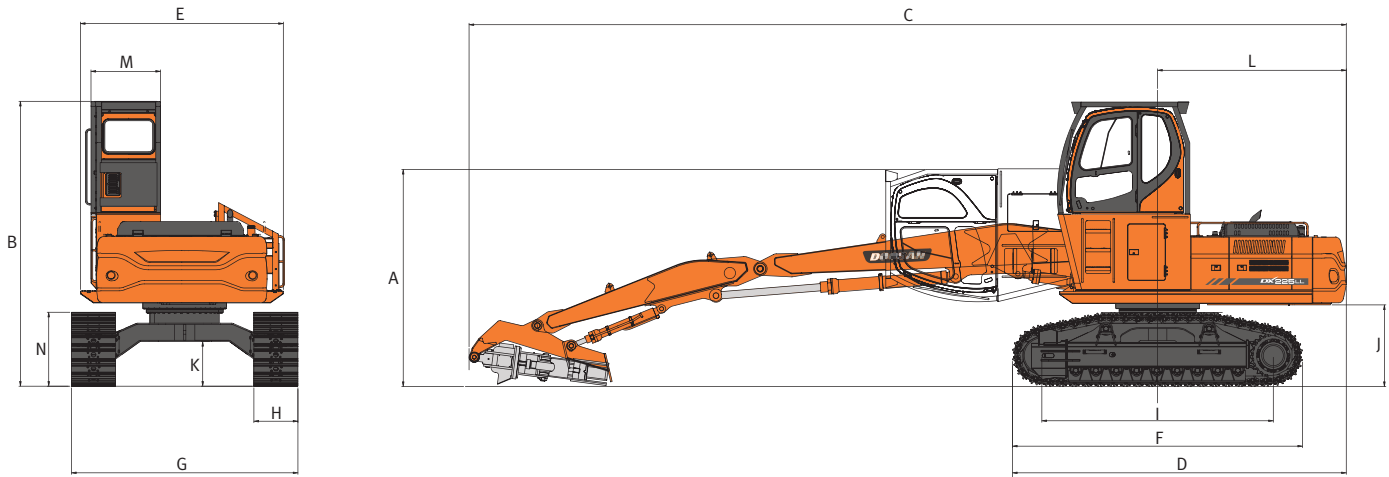

DX225LL

BOOM TYPE		ft. in. (mm)	20'2" (6150)
ARM TYPE		ft. in. (mm)	12' (3660)
HEEL		ft. in. (mm)	2'8" (813)
TRACK TYPE			DOUBLE GROUSER
OVERALL TRANSPORT HEIGHT (W/CABIN DOWN)	A	ft. in. (mm)	11'4" (3453)
OVERALL HEIGHT	B	ft. in. (mm)	14'10" (4530)
OVERALL LENGTH	C	ft. in. (mm)	45'9" (13 947)
OVERALL LENGTH (W/O FRONT)	D	ft. in. (mm)	17'5" (5308)
WIDTH OF UPPER STRUCTURE	E	ft. in. (mm)	10'7" (3226)
OVERALL TRACK LENGTH	F	ft. in. (mm)	15'2" (4613)
UNDERCARRIAGE WIDTH	G	ft. in. (mm)	11'10" (3600)
TRACK SHOE WIDTH	H	in. (mm)	28" (700)
TUMBLER DISTANCE	I	ft. in. (mm)	12'1" (3680)
COUNTERWEIGHT CLEARANCE	J	ft. in. (mm)	4'3" (1299)
MINIMUM GROUND CLEARANCE	K	ft. in. (mm)	2'4" (711)
TAIL SWING RADIUS	L	ft. in. (mm)	9'10" (3000)
CABIN GUARD WIDTH	M	ft. in. (mm)	3'8" (1105)
TRACK HEIGHT	N	ft. in. (mm)	3'10" (1176)
TAIL SWING OVERHANG (OVER SIDE)	—	ft. in. (mm)	3'11" (1200)
CAB RISER HEIGHT	—	ft. in. (mm)	3'11" (1200)
HYDRAULIC TILTING ANGLE	d	degrees	90°

DX300LL-3

BOOM TYPE		ft.-in. (mm)	20'8" (6300)
ARM TYPE		ft.-in. (mm)	12'10" (3912)
HEEL		ft. in. (mm)	3'3" (990)
TRACK TYPE			DOUBLE GROUSER
OVERALL TRANSPORT HEIGHT (W/CABIN DOWN)	A	ft. in. (mm)	11'9" (3590)
OVERALL HEIGHT	B	ft. in. (mm)	15'3" (4650)
OVERALL LENGTH	C	ft. in. (mm)	47'8" (14540)
OVERALL LENGTH (W/O FRONT)	D	ft. in. (mm)	18'7" (5675)
WIDTH OF UPPER STRUCTURE	E	ft. in. (mm)	11'5" (3480)
OVERALL TRACK LENGTH	F	ft. in. (mm)	16'2" (4920)
UNDERCARRIAGE WIDTH	G	ft. in. (mm)	11'10" (3600)
TRACK SHOE WIDTH	H	in. (mm)	28" (700)
TUMBLER DISTANCE	I	ft. in. (mm)	13'2" (4010)
COUNTERWEIGHT CLEARANCE	J	ft. in. (mm)	4'8" (1415)
MINIMUM GROUND CLEARANCE	K	ft. in. (mm)	2'7" (790)
TAIL SWING RADIUS	L	ft. in. (mm)	10'6" (3200)
CABIN GUARD WIDTH	M	ft. in. (mm)	3'4" (1015)
TRACK HEIGHT	N	ft. in. (mm)	4'1" (1250)
TAIL SWING OVERHANG (OVER SIDE)	—	ft. in. (mm)	4'7" (1400)
CAB RISER HEIGHT	—	ft. in. (mm)	3'11" (1200)
HYDRAULIC TILTING ANGLE	d	degrees	90°

Working Range

DX225LL

BOOM	ft. in. (mm)	20'2" (6150)
ARM	ft. in. (mm)	12' (3660)
HEEL	ft. in. (mm)	2'8" (813)
TRACK TYPE		DOUBLE GROUSER
MAX. LOADING REACH	ft. in. (mm)	36'2" (11 035)
MAX. LOADING DEPTH	ft. in. (mm)	11'2" (3410)
MAX. LOADING HEIGHT	ft. in. (mm)	42'5" (12 920)
REAR SWING RADIUS	ft. in. (mm)	9'10" (3000)
MIN. SWING RADIUS	ft. in. (mm)	13'8" (4155)

DX300LL-3

BOOM	ft. in. (mm)	20'8" (6300)
ARM	ft. in. (mm)	12'10" (3912)
HEEL	ft. in. (mm)	3'3" (990)
TRACK TYPE		DOUBLE GROUSER
MAX. LOADING REACH	ft. in. (mm)	38'3" (11 650)
MAX. LOADING DEPTH	ft. in. (mm)	12'3" (3728)
MAX. LOADING HEIGHT	ft. in. (mm)	44'7" (13 580)
REAR SWING RADIUS	ft. in. (mm)	10'6" (3200)
MIN. SWING RADIUS	ft. in. (mm)	13'9" (4182)

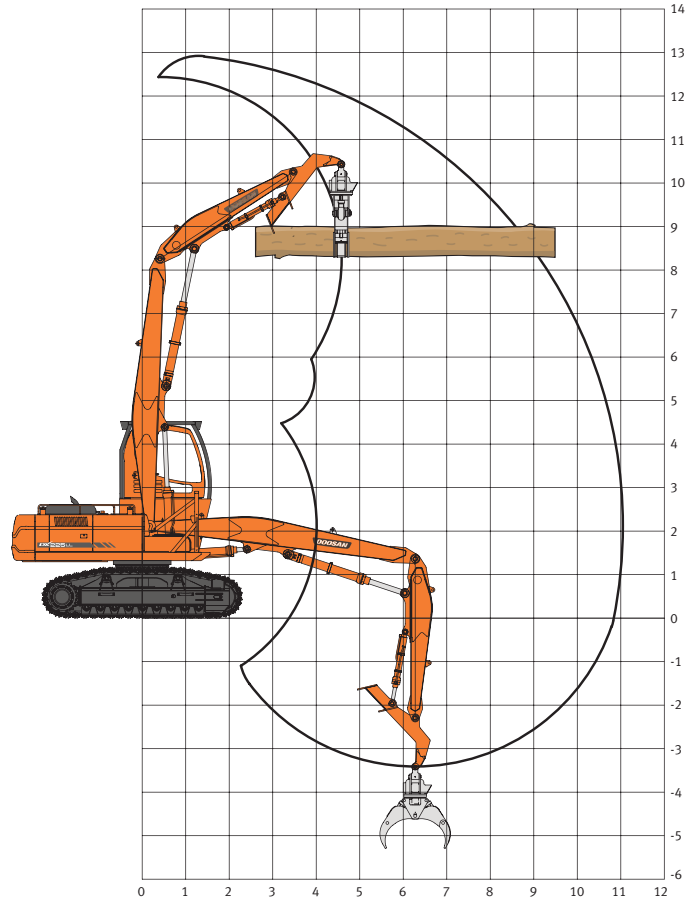

Log Grapple Attachment

Lift more, load more with Doosan log grapples.

- Designed to work harder, last longer and perform better in the field or in the yard, Doosan log grapples deliver the power and performance you need to lift more, load more and be more profitable.

Superb Durability and Serviceability in Extreme Conditions

- T1 steel construction
- Large diameter, induction-hardened pins
- Easy-to-replace, induction-hardened steel bushings
- Heavy-duty, high-pressure, bolted-head hydraulic cylinders
- Large diameter slewing ring with removable guarding
- Bolt-on component guards for additional protection

Productivity Boosting Performance and Flexibility

- Counterbalance-style load holding valves on cylinders hold payload securely, automatically
- High-torque rotation motor with exceptional service life
- Available in 52 in. and 58 in. arm openings

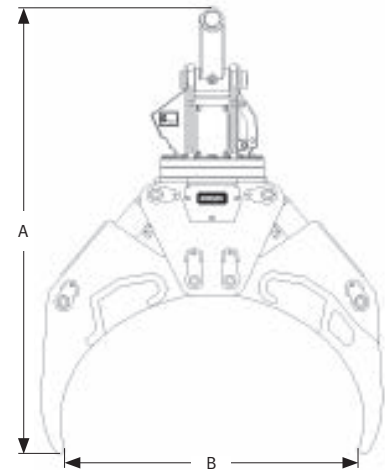

		LG52	LG58
Approved Carriers		DX225LL	DX300LL-3
Height	A	70" (1778 mm)	74" (1880 mm)
Weight		2,200 lb. (998 kg)	2,280 lb. (1034 kg)
Open	B	52" (1321 mm)	58" (1473 mm)
Closed		6" (152 mm)	6" (152 mm)
Rotation		10 rpm	10 rpm

Specifications

Lifting Capacity

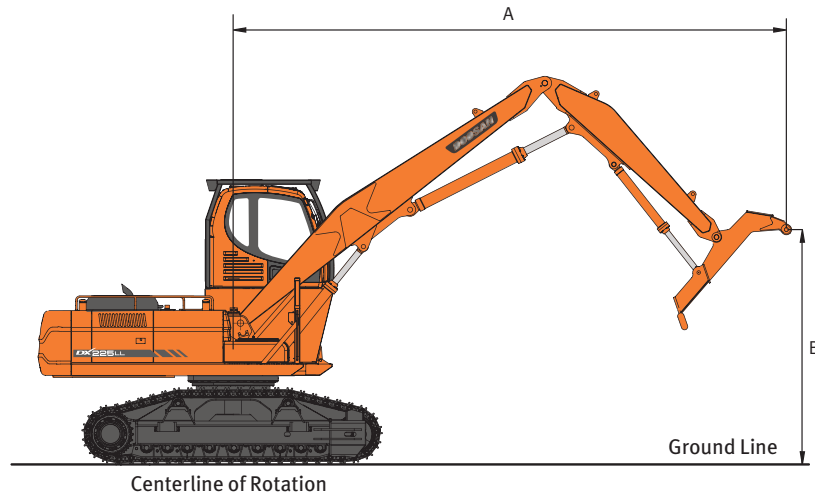

DX225LL (Log Loader front)

Machine Width: 11'10" (3600 mm)
 Boom: 20'2" (6150 mm)
 Arm: 12' (3660 mm)

Grapple: None
 Shoe Width: 28" (700 mm)

Machine Weight: 65,036 lb. (29 500 kg)
 Counter Weight: 10,362 lb. (4700 kg)
 Cab Riser: 3'11" (1200 mm)

Load Radius Over Front
 Load Radius Over Side
 Unit: 1,000 lb. (1000 kg)

Feet

A (ft.) \ B (ft.)	5		10		15		20		25		30		MAX F	MAX S	REACH
															A ft.
35					24.09*	24.09*							23.41*	23.41*	16.01
30					21.01*	21.01*	18.84*	18.15					17.48*	14.37	22.81
25					20.82*	20.82*	18.30*	18.30*	16.66*	12.76			14.84	11.06	27.03
20					22.49*	22.49*	19.02*	18.14	16.70*	12.77			12.73	9.47	29.81
15	41.77*	41.77*	29.56*	29.56*	25.79*	25.79*	20.51*	17.61	16.83	12.54	12.66	9.43	11.63	8.64	31.56
10			2.30*	2.30*	29.60*	25.98	22.18*	16.92	16.48	12.22	12.54	9.32	11.43	8.48	31.88
5			2.54*	2.54*	31.67*	24.63	22.45	16.28	16.14	11.9	12.4	9.19	11.92	8.84	30.83
0 (GROUND)			5.22*	5.22*	25.49*	23.98	22	15.87	15.91	11.68			12.68	9.37	29.39
-5					26.96*	23.88	20.73*	15.73	15.84	11.61			15.54	11.41	25.34

Metric

A (m) \ B (m)	2		3		4		5		6		7		8		9		MAX F	MAX S	REACH
																			A m
11			14.11*	14.11*	12.26*	12.26*											11.92*	11.92*	4.22
10					10.64*	10.64*	9.70*	9.70*									9.04*	8.32	5.93
9					10.05*	10.05*	9.14*	9.14*	8.53*	8.47	8.23*	6.5					7.79*	6.31	7.10
8							9.03*	9.03*	8.35*	8.35*	7.85*	6.65					7.09*	5.29	7.96
7					10.30*	10.30*	9.24*	9.24*	8.45*	8.45*	7.83*	6.67	7.16	5.36			6.27	4.67	8.62
6					11.13*	11.13*	9.75*	9.75*	8.74*	8.43	7.98*	6.62	7.16	5.35	5.89	4.39	5.73	4.27	9.13
5			11.46*	11.46*	12.41*	12.41*	10.50*	10.50*	9.19*	8.27	8.23*	6.52	7.11	5.31	5.9	4.4	5.38	4	9.50
4	6.73*	6.73*	18.76*	18.76*	14.02*	14.02*	11.40*	10.65	9.73*	8.07	8.54*	6.4	7.03	5.24	5.87	4.37	5.16	3.83	9.75
3			1.49*	1.49*	15.57*	14.49	12.28*	10.27	10.24*	7.85	8.49	6.27	6.95	5.16	5.82	4.33	5.32	3.95	9.54
2			1.76*	1.76*	6.96*	6.96*	12.89*	9.93	10.52	7.64	8.35	6.14	6.86	5.07	5.78	4.28	5.06	3.75	9.86
1			0.64*	0.64*	5.74*	5.74*	13.07*	9.68	10.34	7.47	8.23	6.03	6.79	5.01	5.74	4.25	5.14	3.81	9.73
0 (GROUND)			2.21*	2.21*	6.69*	6.69*	12.75*	9.53	10.22	7.36	8.15	5.95	6.73	4.96	5.71	4.22	5.56	4.11	9.18

- Load point is the end of the arm.
- Capacities marked with an asterisk (*) are limited by hydraulic capacities.
- Lift capacities shown do not exceed 75% of minimum tipping loads or 87% of hydraulic capacities.
- The least stable position is over the side.
- The total mass of machine includes the mass of the boom, arm, counterweight, all operating fluids and a 75 kg operator.
- Lift capacities are in compliance with ISO 10567.

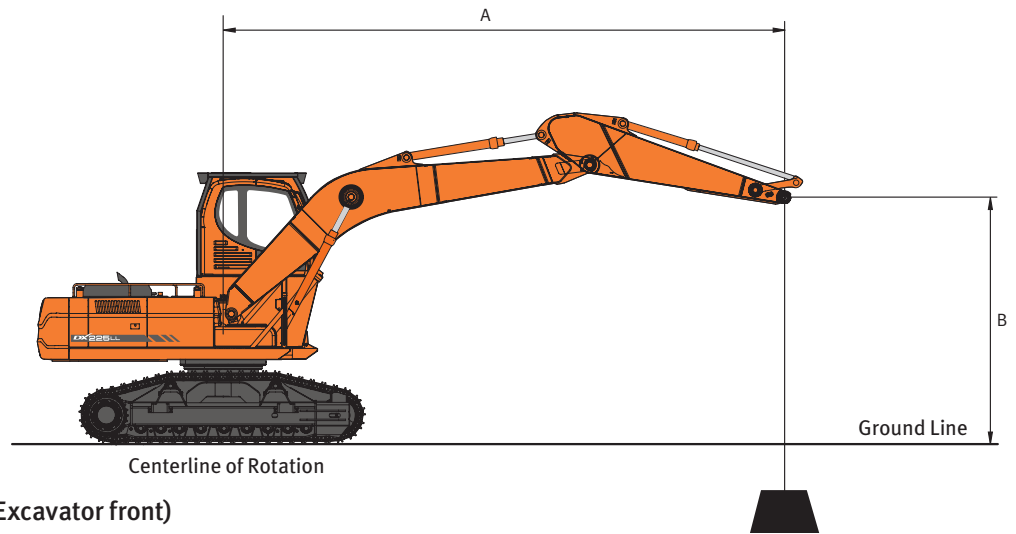

DX225LL (Standard Excavator front)

Machine Width: 11'10" (3600 mm)
 Boom: 18'8" (5700 mm)
 Arm: 9'6" (2900 mm)

Bucket: None
 Track Width: 28" (700 mm)

Machine Weight: 62,611 lb. (28 400 kg)
 Counter Weight: 10,362 lb. (4700 kg)
 Cab Riser: 3'11" (1200 mm)

Load Radius Over Front
 Load Radius Over Side
 Unit: 1,000 lb. (1000 kg)

Feet

B (ft.) \ A (ft.)	5		10		15		20		25		MAX F	MAX S	REACH
													A ft.
25											9.34*	9.34*	21.05
20											8.77*	8.77*	24.53
15							12.15*	12.15*	11.48*	11.48*	8.69*	8.69*	26.63
10					18.39*	18.39*	14.23*	14.23*	12.40*	12.15	8.97*	8.97*	27.67
5					22.37*	22.37*	16.32*	16.22	13.46*	11.9	9.64*	9.64*	27.77
0 (GROUND)			14.96*	14.96*	24.47*	23.94	17.78*	15.88	14.21*	11.73	10.86*	10.63	26.93
-5	16.63*	16.63*	25.49*	25.49*	24.73*	23.85	18.20*	15.77	13.75*	11.73	13.11*	11.7	25.07
-10	27.48*	27.48*	33.26*	33.26*	23.12*	23.12*	16.97*	15.93			14.91*	14.14	21.91
-15			26.15*	26.15*	18.17*	18.17*					15.65*	15.65*	16.70

Metric

B (m) \ A (m)	1		2		3		4		5		6		7		8		MAX F	MAX S	REACH
																			A m
7																	4.10*	4.10*	6.91
6												4.97*	4.97*				3.97*	3.97*	7.53
5										5.31*	5.31*	5.15*	5.15*				3.93*	3.93*	7.98
4								6.59*	6.59*	5.89*	5.89*	5.49*	5.49*	5.29*	5.19		3.97*	3.97*	8.27
3					9.78*	9.78*	7.68*	7.68*	6.56*	6.56*	5.91*	5.91*	5.52*	5.13			4.08*	4.08*	8.44
2					11.43*	11.43*	8.71*	8.71*	7.23*	7.23*	6.34*	6.12	5.78*	5.07			4.26*	4.26*	8.49
1					12.48*	12.48*	9.52*	9.52*	7.80*	7.45	6.72*	6.03	6.01*	5.02			4.53*	4.53*	8.41
0 (GROUND)				6.56*	6.56*	12.94*	12.94*	10.02*	9.52	8.20*	7.36	7.00*	5.96	6.15*	4.99		4.93*	4.82	8.21
-1			6.57*	6.57*	9.55*	9.55*	12.99*	12.99*	10.23*	9.47	8.39*	7.31	7.12*	5.94			5.51*	5.09	7.88
-2	8.56*	8.56*	9.77*	9.77*	13.15*	13.15*	12.67*	12.67*	10.11*	9.48	8.33*	7.32	6.98*	5.95			6.44*	5.56	7.39
-3			13.41*	13.41*	15.36*	15.36*	11.95*	11.95*	9.62*	9.55	7.88*	7.38					6.75*	6.36	6.71
-4			18.24*	18.24*	13.53*	13.53*	10.65*	10.65*	8.54*	8.54*							7.00*	7.00*	5.79
-5					10.50*	10.50*	8.16*	8.16*									7.10*	7.10*	4.46

Specifications

Lifting Capacity

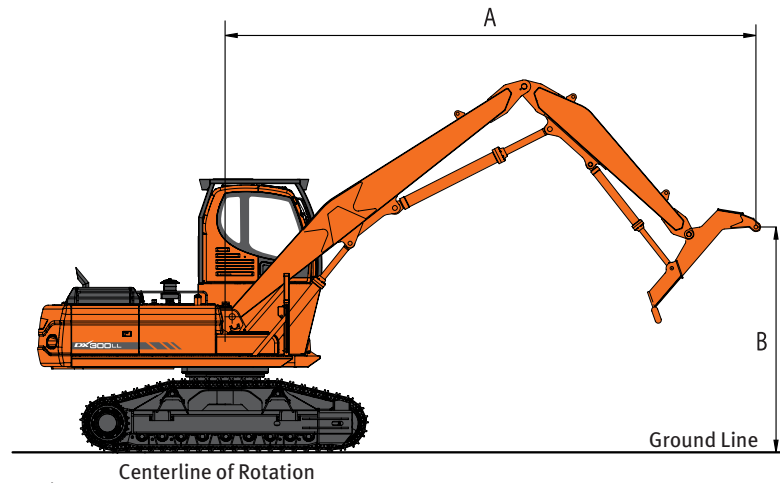



DX300LL-3 (Log Loader front)











Machine Width: 11'10" (3600 mm)
 Boom: 20'8" (6150 mm)
 Arm: 12'10" (3912 mm)

Grapple: None
 Track Width: 2'4" (700 mm)

















Machine Weight: 80,910 lb. (36 700 kg)
 Counter Weight: 13,890 lb. (6300 kg)
 Cab Riser: 3'11" (1200 mm)

 Load Radius Over Front
 Load Radius Over Side
 Unit: 1,000 lb. (1000 kg)

Feet

B (ft.) \ A (ft.)	15		20		25		30		MAX F	MAX S	REACH
											A ft.
35									27.41*	27.41*	18.77
30			24.21*	24.21*					22.34*	17.94	24.67
25			24.07*	24.07*	21.37*	17.96			19.33	14.34	28.47
20	30.29*	30.29*	25.13*	25.13*	21.67*	17.84	17.87	13.27	16.85	12.49	31.02
15	34.33*	34.33*	26.95*	24.60	22.41*	17.48	17.78	13.19	15.53	11.49	32.62
10			28.78*	23.64	23.11*	17.02	17.57	12.99	14.92	11.02	33.39
5			29.60*	22.76	22.67	16.57	17.35	12.78	14.70*	10.97	33.38
0 (GROUND)	28.42*	28.42*	28.54*	22.20	22.15*	16.26	16.92*	12.66	13.06*	11.33	32.61
-5	32.17*	32.17*	25.12*	22.01	19.27*	16.15			14.97*	13.43	28.71

Metric

B (m) \ A (m)	4		5		6		7		8		9		10		MAX F	MAX S	REACH
																	A m
11			13.53*	13.53*											13.37*	13.37*	5.20
10			12.4*	12.4*	11.47*	11.47*									11.15*	9.92	6.62
9					11.02*	11.02*	10.31*	9.27							10.01*	7.96	7.64
8					10.96*	10.96*	10.14*	9.35	9.49*	7.49					9.17	6.80	8.43
7					11.16*	11.16*	10.21*	9.33	9.44*	7.52	8.28	6.14			8.22	6.10	9.04
6			13.05*	13.05*	11.57*	11.57*	10.43*	9.24	9.52*	7.49	8.32	6.18			7.59	5.63	9.49
5	15.40*	15.40*	13.98*	13.98*	12.13*	11.55	10.75*	9.10	9.68*	7.41	8.29	6.16			7.7	5.31	9.83
4			15.04*	14.94	14.74*	11.27	11.11*	8.92	9.86*	7.30	8.23	6.10	6.98	6.16	6.91	5.11	10.06
3			15.97*	14.44	13.28*	10.96	11.41*	8.73	9.75	7.18	8.16	6.03	6.95	5.14	6.76	5.00	10.18
2			16.62*	13.98	13.61*	10.68	11.57*	8.55	9.62	7.06	8.09	5.96	6.93	5.11	6.73	1.96	10.2
1			16.49*	13.64	13.60*	10.45	11.5*	8.40	9.52	6.97	8.03	5.90	6.78*	5.09	6.44*	5.01	10.12
0 (GROUND)			15.82*	13.44	13.16*	10.30	11.11*	8.29	9.44*	6.90	7.91*	5.87			5.92*	5.40	9.84
-1	9.70*	9.70*	14.54*	13.35	12.26*	10.22	10.35*	8.24	8.69*	6.86	6.99*	5.86			6.33*	5.61	9.31
-2			12.67*	12.67*	10.83*	10.22	9.13*	8.23							7.57*	6.94	7.94

*Hydraulically Limited

Standard/Optional Equipment

- Standard Equipment
- Optional Equipment
- N/A

	DX225LL	DX300LL-3
ENGINE		
Emissions (EPA)	T3	IT4
Cooled Exhaust Gas Recirculation (CEGR)	-	•
Diesel Particulate Filter (DPF)	-	•
Variable Geometry (VGT)	-	•
High Pressure Common Rail (HPCR)	•	•
Fuel Filter with Water Separator	•	•
Coolant Recovery Tank	•	•
Dual Element Dry-Type Air Filter with Evacuator	•	•
Pre Cleaner	•	•
Electronic Engine Control	•	•
Auto-Idle	-	•
Overheat & Low Oil Pressure Engine Protection	•	•
HYDRAULIC		
Electronic Power Optimizing System (EPOS)	•	•
Variable Axial Piston Main Pump (Tandem)	•	•
Cross Sensing Pump Control	•	•
Pilot Operated Control Valves	•	•
Gear Pilot Pump	•	•
Variable Speed Hydraulic Cooling Fan	-	•
Axial Piston Swing Motor	•	•
Spring Applied Hydraulic Release Brake	•	•
Axial Piston Travel Motor (High/Low)	•	•
Auxiliary Hydraulics, Two-Way	•	•
Adjustable Auxiliary Flow & Pressure, 10 Presets	-	•
CABIN		
Steel, All-Weather & Sound Suppressed	•	•
Viscous Mount	•	•
Front Window with Wiper/Washer	•	•
Tinted Safety Glass	•	•
Skylight	•	•
Visor, Front Window and Skylight	•	•
Pull Up Type Front Window	•	•
Removable Lower Front Window with Storage Behind Seat	•	•
Adjustable Sliding Side Door Windows	•	•
Defrost, Front Window	•	•
Lockable Doors	•	•
Seat		
- Heated		
- Air Suspension		
- 2" (51 mm) Seat Belt	•	•
- Adjustable Height & Recline		
- Adjustable Arm Rests		
3" (76 mm) Seat Belt	■	■
Control Stands	•	•
- Height Adjustable		
- Mounted to Seat Base		
Storage for Operator's Manuals	•	•
Fully Automatic HVAC w/ Ambient Temperature Sensor	•	•
Multi-Function LCD	•	•
Cigarette Lighter	•	•
AM/FM Stereo with CD Player & MP3 Port	•	•
Speakers (2)	•	•
Antenna	•	•
Emergency Breakout Tool	•	•
Beverage Compartment	•	•
Power Socket, 12V	•	•
Beverage Holder	•	•
Interior Light	•	•
Coat Hanger	•	•
Forestry Cab	■	■

	DX225LL	DX300LL-3
ELECTRICAL		
Alternator - 24V	•	•
2 x 12V Batteries, 150 AH Reserve Capacity	-	•
2 x 12V Batteries, 100 AH Reserve Capacity	•	-
Blade Type Fuse Panel	•	•
Main Circuit Breaker	•	•
Lights, Work (Halogen)	•	•
Hour Meter	•	•
Engine Restart Prevention System	•	•
Rear View Camera	-	•
Laptop Service Port	•	•
Self-Diagnostics System	•	•
Telematics	•	•
DISPLAY MONITOR & WARNINGS		
Buzzer		
- Engine Oil Pressure	•	•
- Coolant Temperature		
Gauges		
- Engine Coolant Temperature	•	•
- Fuel Level		
- Hydraulic Oil Temperature		
- Engine RPM		
- Battery Voltage		
- Hydraulic Pump Pressure		
- ECO (DX300LL-3 Only)		
- Digital Clock		
Warning & Indicator Lights		
- Hydraulic Oil Temperature - High		
- Fuel Level - Low		
- Air Filter - Clogged		
- Hydraulic Pilot Filter - Clogged		
- Hydraulic Return Filter - Clogged		
- Check Engine		
- Engine Oil Pressure - Low	•	•
- Hydraulic Charge Pressure - Low		
- Engine Pre-Heat Engaged		
- Coolant Temperature - High		
- Work Lights On		
- Water in Fuel		
- DPF Regeneration (DX300LL-3 Only)		
- DPF High Temperature Exhaust (DX300LL-3 Only)		
Travel Alarm	•	•
UNDERCARRIAGE		
Full Length Track Guards	•	•
Track Rollers, Upper (2 Each Side)	•	•
Track Rollers, Lower (9 Each Side)	•	•
In-Shoe Motor Protection	•	•
Shoes, Double Grouser - 700 mm	•	•
CONTROLS		
Joystick Attachment Control Switches/Buttons		
- Two-way	•	•
- Power Boost		
Control Stands		
- Height Adjustable	•	•
- Sliding (Fore/Aft)		
Engine Speed Control Dial	•	•
Travel Pedals with Hand Levers	•	•
Straight Travel Pedal	-	■
Switches, Console Mounted		
- Starter (Key)		
- Travel Speed Selector	•	•
- Work Light		
- DPF Regeneration (DX300LL - 3 only)		
- Emergency Stop Switch		
Power Mode (P, S, E)	•	-
Power Mode (P+, P, S, E)	-	•
Jog Dial Display Control	-	•
Wiper Control Panel	•	•
Audio Control Panel	•	•
OTHER		
Handrails	•	•
Skid-Resistant Steps	•	•
Manuals		
- Operations & Maintenance	•	•
- Parts		
- AEM Safety Manual		
Telematics, 1 Year Subscription	•	•
Vandalism Protection	•	•
- Lockable Fluid Fill Points		



DOOSAN

**A NAME YOU CAN'T FORGET.
PRODUCTS YOU CAN'T IGNORE.**

If you want to do more, there are two simple syllables you need to remember. Doosan. Doosan delivers performance, productivity, durability, comfort and easy maintenance in all of its machines. When you look into our products and our committed dealer and support networks, you'll know that we're up for your biggest, toughest jobs. And once you experience for yourself what these machines can do, you'll never forget it.



DOOSAN



Printed on 10% recycled paper

1.877.613.7970
DoosanEquipment.com/LL

Doosan and the Doosan logo are registered trademarks of Doosan Corp. in the United States and various other countries around the world.
©2014 Doosan Infracore Construction Equipment America. All rights reserved.